

Vario-Sonnar T*
f/3.5 –
70 to 210 mm
Cat. No. 104728

CONTAX
YASHICA mount

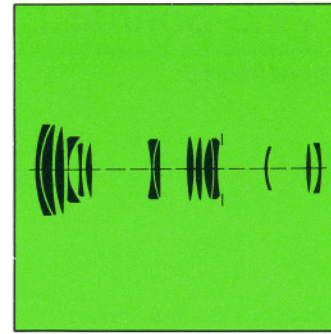

ZEISS

Carl Zeiss
D-7082 Oberkochen
West Germany

With a focal length variation of factor 3 this Vario-Sonnar covers the range between the standard focal length and extreme tele focal lengths. The optimal angle of view can be selected exactly by continuously varying the focal length, while fully retaining the sharp focus as well as the speed of f/3.5, which is remarkably high considering the handy size of the lens. At the longest focal length of 210 mm in the zoom range and with front element focusing to the shortest object distance of 1.8 m, an object area of 170x255 mm fully covers the negative format of 24x36 mm.

After changing over to the macro range by setting the focal length to 210 mm and then moving the focal length setting ring towards shorter focal lengths, the distance of the sharply focused object plane rapidly decreases and, on the other hand, the image scale increases. At an object distance of 0.3 m from the film plane, an area as small as 46x69 mm fully covers the negative format. At this distance, which corresponds to an image scale of about 1:2, the depth of field for

f-number 11 is scarcely ± 2 mm. Therefore, when working with the Vario-Sonnar in macro position, one should stop down appropriately, just as one has to with other macro lenses.

Unusual sharpness and contrast over the entire zoom range from 70 to 210 mm focal length secure for this Vario-Sonnar a top position among lenses of its class, even at full aperture. Full advantage of the flexibility of the Vario-Sonnar can be taken when photographing in rapidly changing situations.

The possibilities of this lens are multiplied by the fact that after simple switch-over it can be used in the macro range, which is of particular importance in nature photography and for technical and scientific applications.

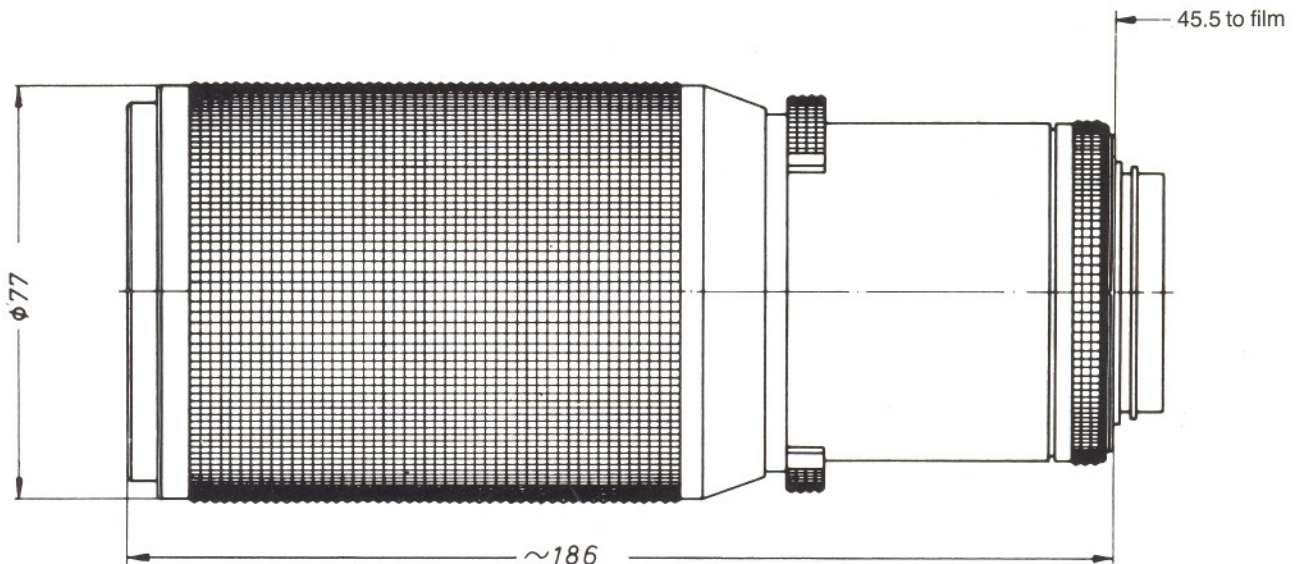

Number of lens elements: 15
Number of groups: 12
f-number: 3.5
Focal length: 72.0 - 203.0 mm
Negative size: 24 x 36 mm
Angular field 2w: 33° - 12°
Mount: focusing mount with bayonet; coupling system for automatic diaphragm function; through-the-lens measurement either at full aperture or in stopped-down position
Aperture scale: 3.5 - 5.6 - 8 - 11 - 16 - 22
Filter: slip-on filter, diameter 70 mm screw thread M 67 x 0.75
Weight: approx. 1145 g

Focusing range: ∞ to 1.8 (6 feet), macro setting
Position of entrance pupil:
a 63.9 mm behind first lens vertex
b 30.7 mm behind last lens vertex
Diameter of entrance pupil:
a 19.9 mm
b 56.0 mm
Position of exit pupil:
a 48.0 mm in front of last lens vertex
b 48.0 mm in front of last lens vertex
Diameter of exit pupil:
a 27.0 mm
b 27.0 mm
Position of principal plane H:
a 82.4 mm behind first lens vertex
b 12.6 mm in front of last lens vertex
Position of principal plane H':
a 22.8 mm in front of last lens vertex
b 153.9 mm in front of last lens vertex
Distance between first and last lens vertex:
178.6 mm a) for f = 72.0 mm
b) for f = 203.0 mm

Performance data: Vario-Sonnar T* f/3.5–70 to 210 mm Cat. No. 1047 28

Modulation transfer T as a function of image height u
 Slit orientation tangential ————
 sagittal ————

White light
 Spatial frequencies R = 10, 20 and 40 cycles/mm

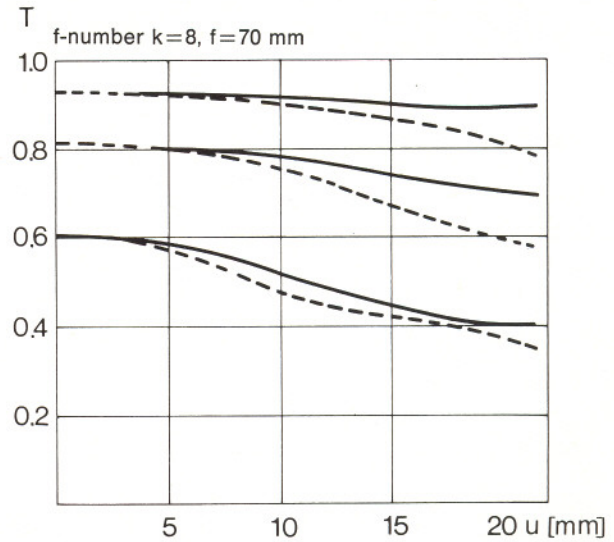
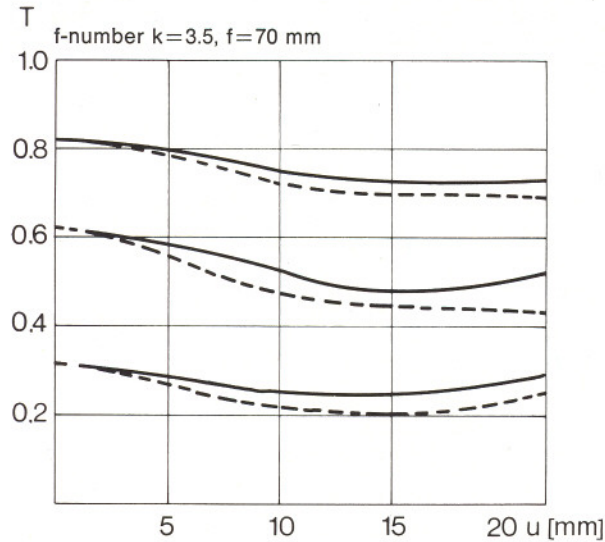

1. MTF Diagrams

The image height u – reckoned from the image center – is entered in mm on the horizontal axis of the graph. The modulation transfer T (MTF = Modulation Transfer Factor) is entered on the vertical axis. Parameters of the graph are the spatial frequencies R in cycles (line pairs) per mm given at the top right hand above the diagrams. The lowest spatial frequency corresponds to the upper pair of curves, the highest spatial frequency to the lower pair. Above each graph the f -number k is given for which the measurement was made. "White" light means that the measurement was made with a subject illumination having the approximate spectral distribution of daylight.

Unless otherwise indicated, the performance data refer to large object distances, for which normal photographic lenses are primarily used.

2. Relative illuminance

In this diagram the horizontal axis gives the image height u in mm and the vertical axis the relative illuminance E , both for full aperture and a moderately stopped-down lens. The values for E are determined taking into account vignetting and natural light decrease.

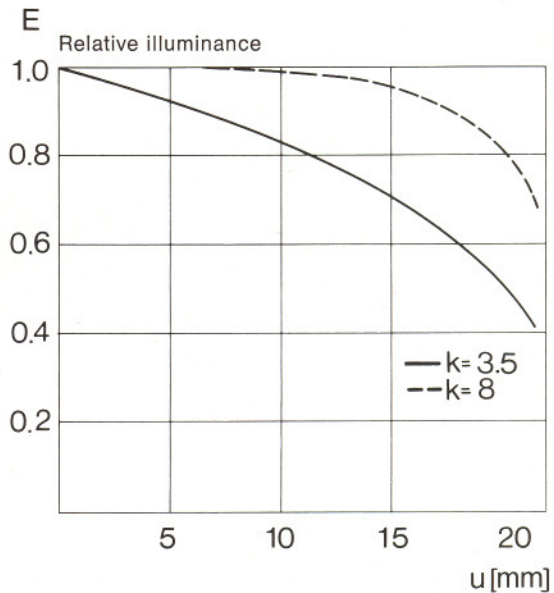

3. Distortion

Here again the image height u is entered on the horizontal axis in mm. The vertical axis gives the distortion V in % of the relevant image height. A positive value for V means that the actual image point is further from the image center than with perfectly distortion-free imaging (pincushion distortion); a negative V indicates barrel distortion.

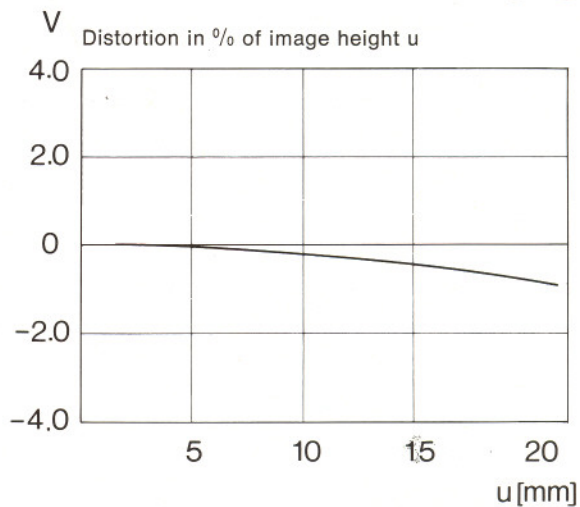

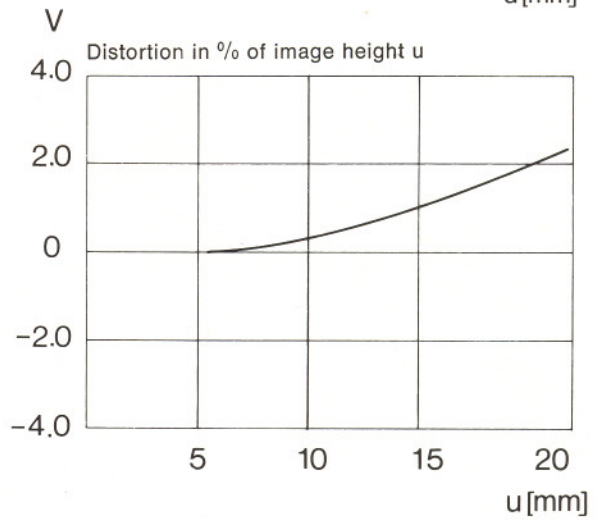
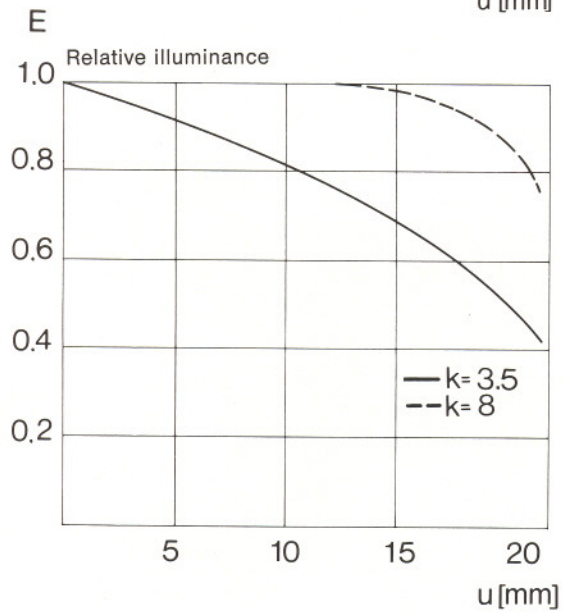
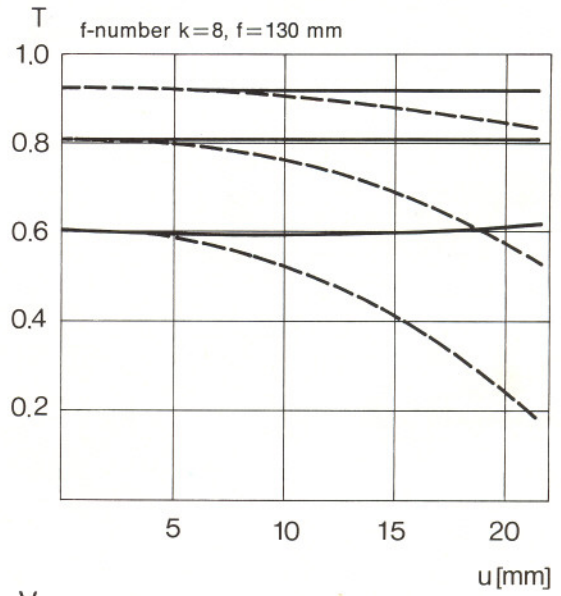
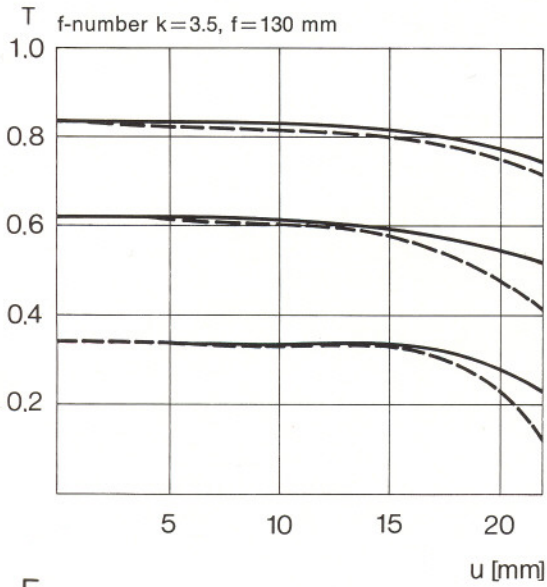

T f-number k=3.5, f=210 mm

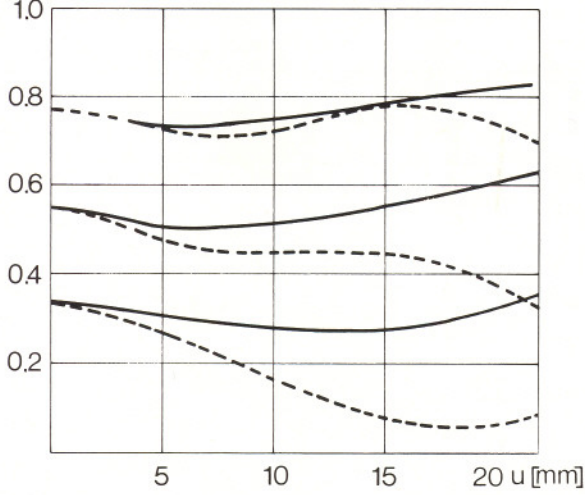

T f-number k=8, f=210 mm

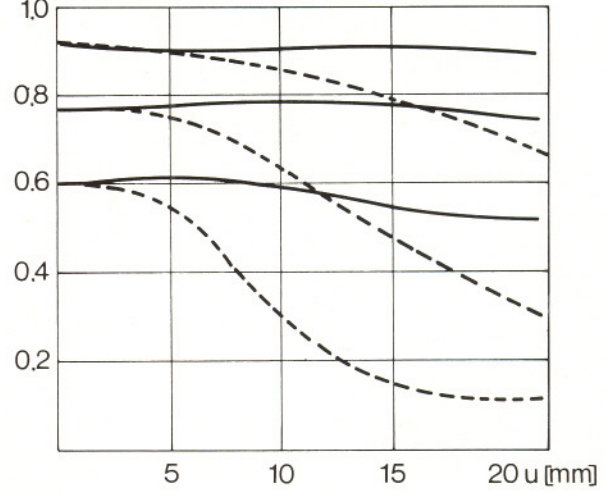

E Relative illuminance

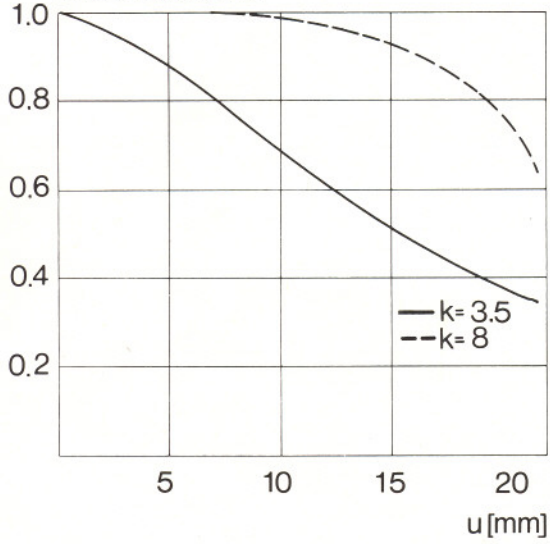

V Distortion in % of image height u

